

THE INDUSTRY CHOICE FOR HIGH-SPEED AND PRECISION MARK DETECTION



B







Additional information

Detailed technical data B-81

Ordering information B-82

Dimensional drawing B-82

Adjustments B-82

Connection diagram B-83

Sensing distance B-83

Setting the switching threshold . . B-83

Recommended accessories B-85

Product description

Extremely high speeds, poor contrasts and reflective materials are no problem for the KT10-2. Ease of use is the defining feature of the second generation of the KT10. Even during the teach-in phase, the sensor selects the transmission color that best matches the existing contrast. And, the sensor adjusts itself if marks need to be detected on glossy foils. In addition, the sensor compensates for dirt build-up on lenses using

automatic drift correction. The KT10-2 offers an exceptionally fast switching frequency, an easy-to-read bar graph display and 2 light exits. The bar graph display provides visible confirmation of the teach-in and can be used to monitor the sensor's status during operation. The sensor's two interchangeable light exits enable the KT10-2 to be mounted in more places.

At a glance

- Very low jitter (< 10 µs)
- Precise light spot
- Best contrast resolution thanks to RGB LED technology
- Two interchangeable light exits
- Automatic drift correction
- Fast switching frequency of 25 kHz
- Easy-to-read bar graph display

Your benefits

- Very precise detection of print marks enables optimal results for packaging and printing applications
- All contrast marks, even pale yellow on white paper, can be reliably detected thanks to RGB LED technology
- Automatic drift correction helps detect difficult to see marks, such as faded print marks, enabling higher production reliability
- Reliable operation, even with high-gloss reflective surfaces, increasing throughput
- Simple teach-in via an external signal can be performed while the material is moving, enabling shorter setup time
- Long-lasting, tough metal housing

→ www.sick.com/de/en/KT10

For more information, just enter the link or scan the QR code and get direct access to technical data, CAD design models, operating instructions, software, application examples and much more.



Detailed technical data

Features

Dimensions (W x H x D)	30.4 mm x 53 mm x 80 mm
Sensing distance ¹⁾	10 mm
Housing design (light emission)	Rectangular
Sensing distance tolerance	± 3 mm
Light source ²⁾	LED
Type of light	RGB
Wave length	640 nm, 525 nm, 470 nm
Light emission	Long and short side of housing, exchangeable
Light spot size	0.8 mm x 4 mm
Light spot direction ³⁾	Vertical / Horizontal (depending on type)
Teach-in mode	Static 2-point teach-in, Dynamic teach-in (min/max)
Function	Automatic drift correction

¹⁾ From front edge of lens.

²⁾ Average service life: 100,000 h at $T_U = +25\text{ °C}$.

³⁾ In relation to long side of housing.

Mechanics/electronics

Supply voltage ¹⁾	10 V DC ... 30 V DC
Ripple ²⁾	≤ 5 V _{pp}
Power consumption ³⁾	< 120 mA
Switching frequency ⁴⁾	25 kHz
Response time ⁵⁾	20 μs
Jitter	< 10 μs
Switching output	PNP: HIGH = $V_S - \leq 2\text{ V}$ / LOW approx. 0 V / NPN: HIGH = approx. V_S / LOW ≤ 2 V,
Output type	PNP / NPN (depending on type)
Output current I_{max}	100 mA
Input, teach-in (ET)	PNP: Teach: $U = 10\text{ V} \dots < U_V$; Run: $U < 2\text{ V}$ NPN: Teach: $U < 2\text{ V}$; Run: $U = 10\text{ V} \dots < U_V$
Input, blanking input (AT)	PNP: Blanked: $U > 10\text{ V} \dots < U_V$; Free-running: $U < 2\text{ V}$ ⁶⁾ NPN: Blanked: $U < 2\text{ V}$; Free-running: $U > 10\text{ V} \dots < U_V$ ⁶⁾
Retention time (ET)	25 ms, non-volatile memory
Time delay	20 ms, adjustable
Connection type	Connector M12, 5-pin
Protection class ⁷⁾	II
Circuit protection	V_S connections reverse-polarity protected, Output Q short-circuit protected, Interference suppression, Outputs overcurrent and short-circuit protected
Enclosure rating	IP 67
Weight	400 g
Housing material	Metal, zinc diecast

¹⁾ Limit values; operation in short-circuit protected network max. 8 A.

²⁾ May not exceed or fall below U_V tolerances.

³⁾ Without load.

⁴⁾ With light/dark ratio 1:1.

⁵⁾ Signal transit time with resistive load.

⁶⁾ AT > 200 μs.

⁷⁾ Reference voltage DC 50 V.

Ambient data

Ambient operating temperature	-10 °C ... +55 °C
Ambient storage temperature	-10 °C ... +75 °C
Shock load	According to IEC 60068
UL File No.	NRKH.E181493 & NRKH7.E181493

B

Ordering information

Other models → www.sick.com/de/en/KT10

Light spot direction ¹⁾	Output type	Type	Part no.
Vertical	PNP	KT10W-2P1115	1028232
	NPN	KT10W-2N1115	1028233
Horizontal	PNP	KT10W-2P2115	1029070
	NPN	KT10W-2N2115	1029071

¹⁾ In relation to long side of housing.

Dimensional drawing (Dimensions in mm (inch))

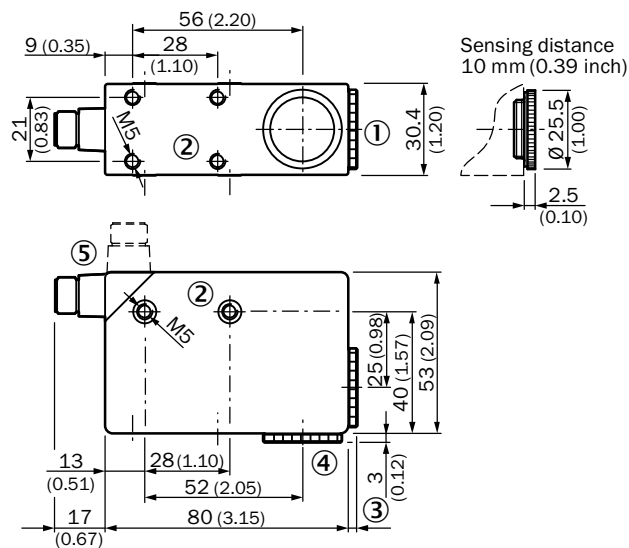

- ① Lens (light transmission)
- ② M5 threaded mounting hole, 5.5 mm deep
- ③ See dimensional drawing of lens
- ④ Blind screw can be replaced by pos. 1
- ⑤ Connector M12 (rotatable up to 90°)

Adjustments

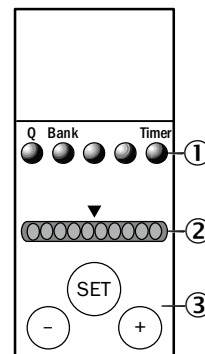

- ① Function signal indicators (yellow)
- ② Bar graph (green)
- ③ Teach-in button/"+" and "-" button

Connection diagram

Cd-313

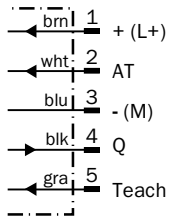

Sensing distance

KT8 CAN, KT10-2

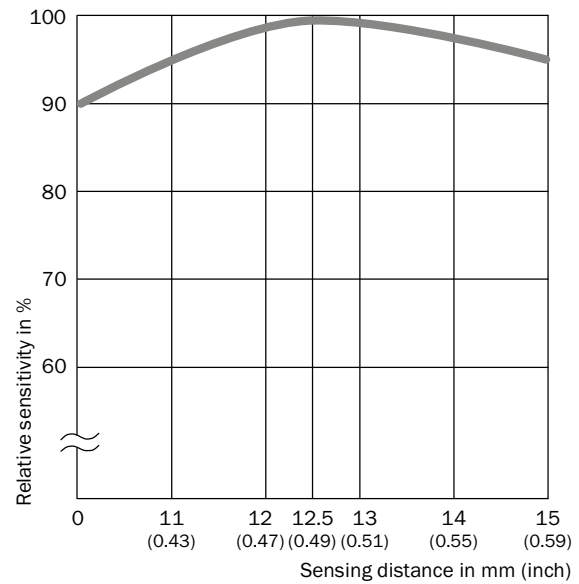

B

Setting the switching threshold

Teach-in dynamic

1. Position background

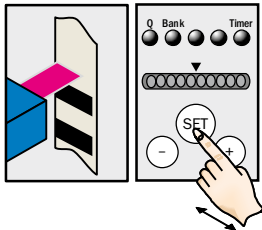

Press and hold SET button. Emitted light turns white.

2. Move at least one repeat length using the light spot

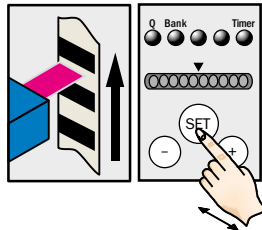

Hold down SET button.

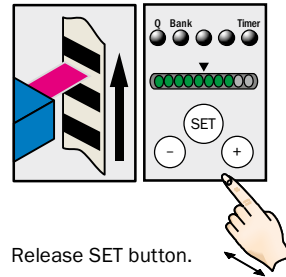

Release SET button.

Teach-in static

1. Position mark

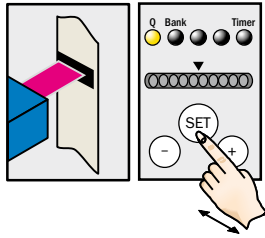

Press and hold SET button > 1 s.
Red emitted light and yellow LED flash.

2. Position background

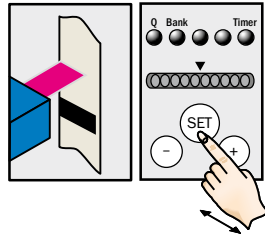

Press and hold SET button > 1 s.
Yellow LED goes out.
Optimum emitted light is selected.

B

Note

The bar display visualizes the detection reliability during teach-in. The more LEDs that illuminate, the better the teach-in:

- 1 LED illuminates = operation not reliable - lowest contrast difference
- ≤ 4 LEDs illuminate = operation OK - sufficient contrast difference
- > 4 LEDs illuminate = reliable operation - high contrast difference

Example

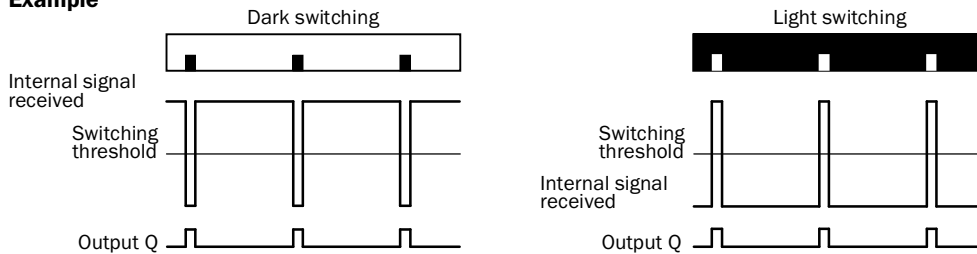







Switching characteristics

Light/dark setting is defined using teach-in sequence.
The switching threshold is set in the center between the background and the mark.
Teach-in and the light/dark setting can also be configured using an external control signal.

Recommended accessories

Universal bar clamp systems



Figure	Material	Description	Type	Part no.
	Steel, zinc coated	Plate G for universal clamp bracket	BEF-KHS-G01	2022464
		Plate K for universal clamp bracket	BEF-KHS-K01	2022718
		Universal clamp bracket for rod mounting	BEF-KHS-KH1	2022726
		Mounting bar, straight, 200 mm, steel	BEF-MS12G-A	4056054
		Mounting bar, straight, 300 mm, steel	BEF-MS12G-B	4056055
		Mounting bar, L-shaped, 150 mm x 150 mm, steel	BEF-MS12L-A	4056052
		Mounting bar, L-shaped, 250 x 250 mm, steel	BEF-MS12L-B	4056053

B

Plug connectors and cables

Connecting cables with female connector

M12, 5-pin, PVC, chemical resistant

Figure	Connection type head A	Connection type head B	Connecting cable	Type	Part no.
	Female connector, M12, 5-pin, straight, unshielded	Cable, open conductor heads	2 m, 5-wire	DOL-1205-G02M	6008899
			5 m, 5-wire	DOL-1205-G05M	6009868
	Female connector, M12, 5-pin, angled, unshielded	Cable, open conductor heads	2 m, 5-wire	DOL-1205-W02M	6008900
			5 m, 5-wire	DOL-1205-W05M	6009869

→ For additional accessories, please see page K-240