

LASER CONTRAST SENSOR AND CAN COMMUNICATION



B









CDRH

Additional information

Detailed technical data B-73

Ordering information B-74

Dimensional drawings B-74

Adjustments B-75

Connection diagram B-75

Sensing distance B-76

Setting the switching threshold . . B-76

Recommended accessories B-78

Product description

The KT8 contrast sensor family has two versions. The first variant, KT8L, allows a highly reliable detection of the smallest contrast marks and objects thanks to the precise laser. Lasers are used in contrast sensors for either long-range detection (800 mm) or detection of very small objects. The KT8L provides both. Two light spot sizes are available: <0.3 mm for detecting small objects and marks and 3 mm for larger objects and marks. The second variant, KT8 CAN, is distinguished primarily by its ability to

communicate. The CAN interface makes adjusting the sensor and integrating additional functions into a machine easier. Any number of parameter sets can be stored in the machine controller via the CAN interface, such as for different packaging. In addition, important process data, like contamination or current switching thresholds can be queried via the CAN interface. A 3-color LED, gloss adaptation, automatic drift correction and fast response times are also included.

At a glance

- Laser version offers sensing distances of 30 mm to 800 mm
- Very small and precise laser light spot (Class II)
- Fast switching frequency of 17 kHz
- Detection reliability displayed in the bar graph display
- CAN interface version for parameter setup, diagnostics and function selection
- Very precise light spot

Your benefits

- Wide selection of varying distances, depending on the application
- Precise detection of the smallest marks and objects, e.g., 1 x 1 mm²
- Reliable operation, even with unsteady objects
- Easy integration into machine designs, thanks to standard CAN protocol
- Access to the sensor via the control system saves the machine operator time and effort during configuration
- Individual, application-specific configuration and settings
- Automatic drift correction ensures high production reliability with faded print marks and other difficult to detect marks
- Reliable operation, even with high-gloss reflective surfaces, increasing throughput

→ www.mysick.com/en/KT8

For more information, just enter the link or scan the QR code and get direct access to technical data, CAD design models, operating instructions, software, application examples and much more.



Detailed technical data

Features

	KT8 CAN	KT8L Laser
Dimensions (W x H x D)	30.4 mm x 53 mm x 80 mm	
Sensing distance ¹⁾	10 mm / 20 mm (depending on type)	150 mm
Housing design (light emission)	Rectangular	
Light source	LED ²⁾	Laser ³⁾
Type of light	RGB	Red
Wave length	640 nm, 525 nm, 470 nm	655 nm
Light emission	Long and short side of housing, exchangeable	Long side of housing
Light spot direction	Vertical ⁴⁾	Round
Operating distance	-	30 mm ... 800 mm ⁵⁾ (depending on type)
Teach-in mode	Static 2-point teach-in, Dynamic teach-in (min/max)	
Function	Automatic drift correction, Deactivation delay, 10 ms / 20 ms / 40 ms, adjustable, CAN interface	Automatic drift correction

¹⁾ From front edge of lens.

²⁾ Average service life: 100,000 h at $T_U = +25$ °C.

³⁾ Average service life 50,000 h at $T_A = +25$ °C.

⁴⁾ In relation to long side of housing.

⁵⁾ With respect to black-white contrast 6 % / 90 %.

Mechanics/electronics

	KT8 CAN	KT8L Laser
Supply voltage ¹⁾	10 V DC ... 30 V DC	
Ripple ²⁾	$\leq 5 V_{pp}$	
Power consumption ³⁾	< 120 mA	< 80 mA
Switching frequency ⁴⁾	22.5 kHz	17 kHz
Response time ⁵⁾	22 μ s	30 μ s
Jitter	< 11 μ s	< 15 μ s
Switching output	PNP: HIGH = $V_S - \leq 2 V$ / LOW approx. 0 V NPN: HIGH = approx. V_S / LOW $\leq 2 V$,	
Analog output Q_A	-	0.3 mA ... 28.5 mA
Output current I_{max}	100 mA	
Input, teach-in (ET)	PNP: Teach: $U = 10 V \dots < U_V$; Run: $U < 2 V$ NPN: Teach: $U < 2 V$; Run: $U = 10 V \dots < U_V$	
Retention time (ET)	25 ms, non-volatile memory	
Time delay	-	20 ms, adjustable
Connection type	Male connector M12, 8-pin	Connector M12, 5-pin
Protection class	II ⁶⁾	II ⁷⁾
Circuit protection	V_S connections reverse-polarity protected, Output Q short-circuit protected, Interference suppression	
Enclosure rating	IP 67	
Weight	400 g	
Housing material	Metal, zinc diecast	

¹⁾ Limit values; operation in short-circuit protected network max. 8 A.

²⁾ May not exceed or fall below U_V tolerances.

³⁾ Without load.

⁴⁾ With light/dark ratio 1:1.

⁵⁾ Signal transit time with resistive load.

⁶⁾ Reference voltage DC 32 V.

⁷⁾ Reference voltage DC 50 V.

Ambient data

	KT8 CAN	KT8L Laser
Ambient operating temperature	-10 °C ... +55 °C	-10 °C ... +45 °C
Ambient storage temperature	-10 °C ... +75 °C	
Shock load	According to IEC 60068	
UL File No.	NRKH.E181493 & NRKH7.E181493	242368, CDRH-conform

B

Ordering information

Other models → www.mysick.com/en/KT8

KT8 CAN

Sensing distance ¹⁾	Sensing distance tolerance	Light spot size	Output type	Connection diagram	Type	Part no.
10 mm	± 3 mm	0.8 mm x 4 mm	PNP	Cd-328	KT8W-P111C	1027919
			NPN	Cd-328	KT8W-N111C	1028223
20 mm	± 3 mm	1.5 mm x 5.5 mm	PNP	Cd-328	KT8W-P121C	1043689

¹⁾ From front edge of lens.

KT8L Laser

Sensing distance ¹⁾	Operating distance ²⁾	Light spot size ³⁾	Output type	Connection diagram	Type	Part no.
150 mm	30 mm ... 800 mm	∅ 0.3 mm	PNP	Cd-329	KT8L-P3656	1041262
			NPN	Cd-329	KT8L-N3656	1041263
	30 mm ... 600 mm	∅ 3 mm	PNP	Cd-329	KT8L-P3756	1041351
			NPN	Cd-329	KT8L-N3756	1041352

¹⁾ From front edge of lens.

²⁾ With respect to black-white contrast 6 % / 90 %.

³⁾ At focal point = sensing distance 150 mm.

Dimensional drawings (Dimensions in mm (inch))

KT8 CAN

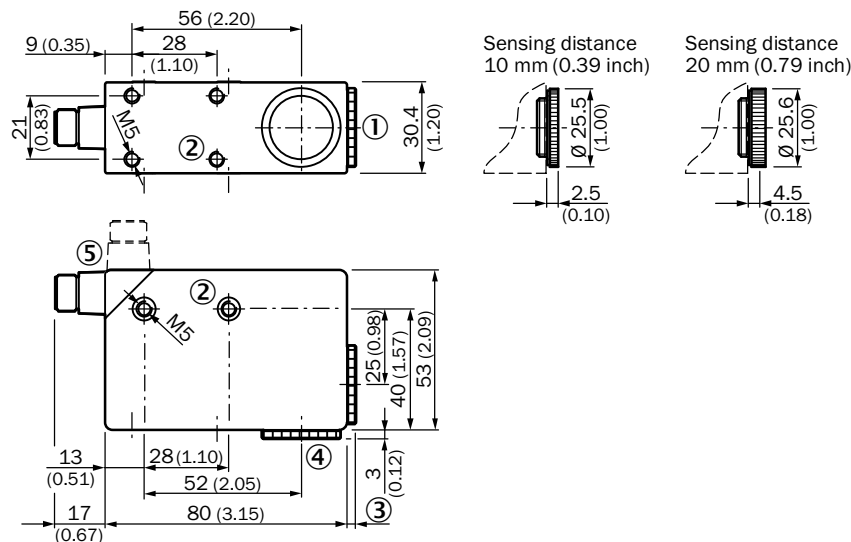

- ① Lens (light transmission), can be exchanged for pos. 4
- ② M5 threaded mounting hole, 5.5 mm deep
- ③ See dimensional drawing for lens
- ④ Blind screw can be replaced by pos. 1
- ⑤ Connector M12 (rotatable up to 90°)

KT8L Laser

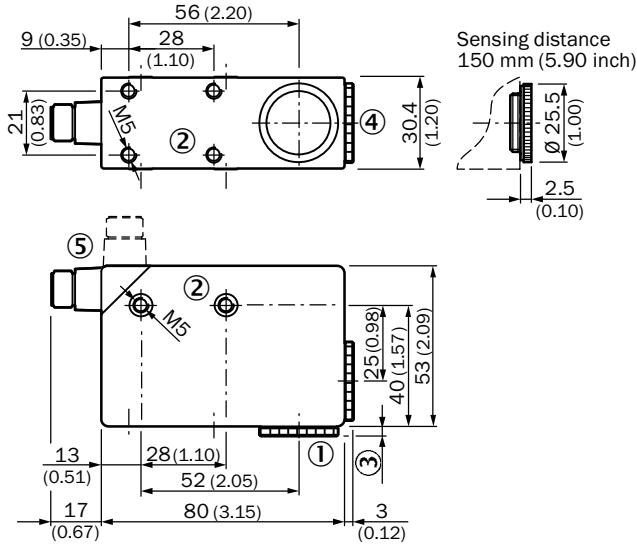

- ① Lens (light transmission), cannot be exchanged for pos. 4
- ② M5 threaded mounting hole, 5.5 mm deep
- ③ See dimensional drawing of lens
- ④ Blind screw cannot be replaced by pos. 1
- ⑤ Connector M12 (rotatable up to 90°)



Adjustments

KT8 CAN

KT8L Laser

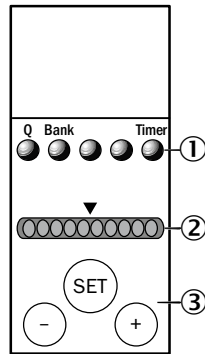
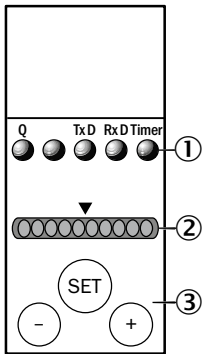

- ① Function signal indicators (yellow)
- ② Bar graph (green)
- ③ Teach-in button/"+" and "-" button

- ① Function signal indicators (yellow)
- ② Bar graph (green)
- ③ Teach-in button/"+" and "-" button

Connection diagram

Cd-328

Cd-329

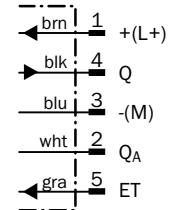
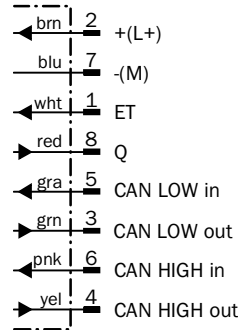

B

Sensing distance

KT8 CAN, KT10-2

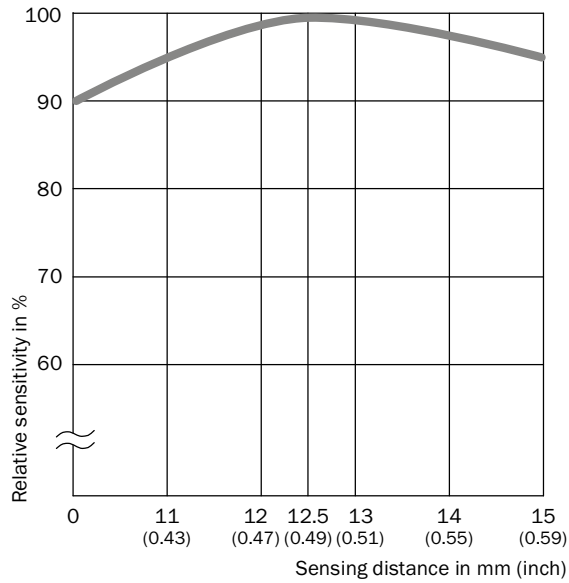

KT8L Laser

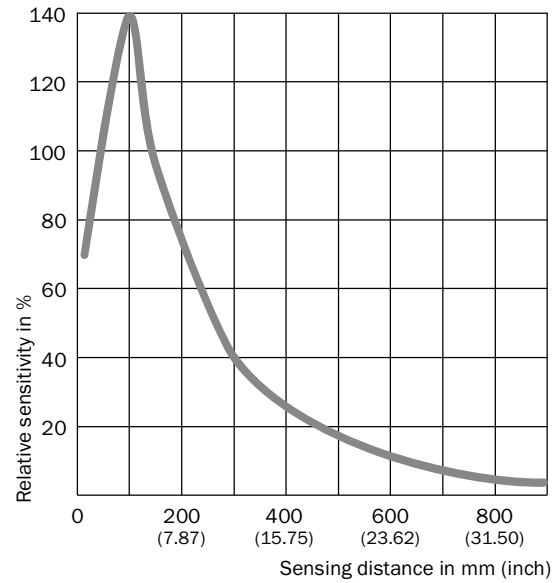

Setting the switching threshold

KT8, Teach-in static (default setting KT8 Laser)

1. Position mark

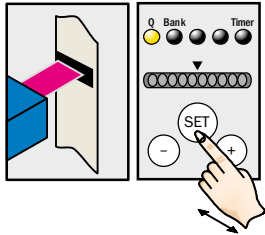

Press and hold SET button > 1 s.
Yellow LED flashes.

2. Position background

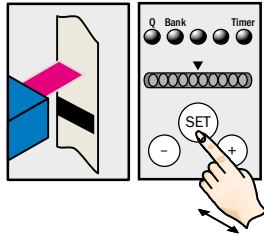

Press and hold SET button > 1 s.
Yellow LED goes out.

KT8, Teach-in dynamic (default setting KT8 CAN)

1. Position background

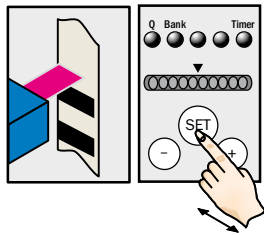

Press and hold SET button.
Emitted light turns white.

2. Move at least one repeat length using the light spot

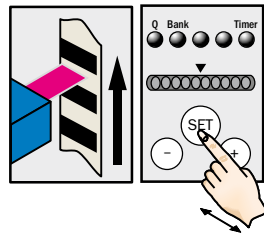

Hold down SET button.

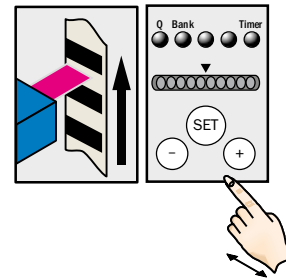

Release SET button.

B

Note

The bar display visualizes the detection reliability during teach-in. The more LEDs that illuminate, the better the teach-in:

- 1 LED illuminates = operation not reliable - contrast difference too low
- ≤ 4 LEDs illuminate = operation OK - sufficient contrast difference
- > 4 LEDs illuminate = reliable operation - high contrast difference

Example

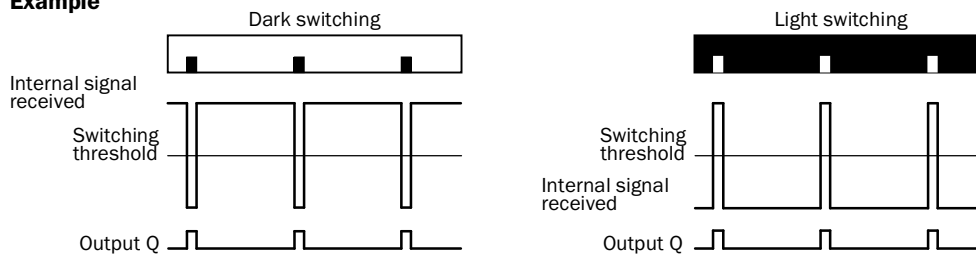







Switching characteristics

Light/dark setting is defined using teach-in sequence or menu, cf. operating instructions.
The switching threshold is set in the center between the background and the mark.
Teach-in and the light/dark setting can also be configured using an external control signal.
Configuration only possible via CAN (see operating instruction).

Recommended accessories

Universal bar clamp systems



B

Figure	Material	Description	Type	Part no.
	Steel, zinc coated	Plate G for universal clamp bracket	BEF-KHS-G01	2022464
		Plate K for universal clamp bracket	BEF-KHS-K01	2022718
		Universal clamp bracket for rod mounting	BEF-KHS-KH1	2022726
		Mounting bar, straight, 200 mm, steel	BEF-MS12G-A	4056054
		Mounting bar, straight, 300 mm, steel	BEF-MS12G-B	4056055
		Mounting bar, L-shaped, 150 mm x 150 mm, steel	BEF-MS12L-A	4056052
		Mounting bar, L-shaped, 250 x 250 mm, steel	BEF-MS12L-B	4056053

Plug connectors and cables

Connecting cables with female connector

M12, 5-pin, PVC, chemical resistant

Figure	Connection type head A	Connection type head B	Connecting cable	Type	Part no.
	Female connector, M12, 5-pin, straight, unshielded	Cable, open conductor heads	2 m, 5-wire	DOL-1205-G02M	6008899
			5 m, 5-wire	DOL-1205-G05M	6009868
	Female connector, M12, 5-pin, angled, unshielded	Cable, open conductor heads	2 m, 5-wire	DOL-1205-W02M	6008900
			5 m, 5-wire	DOL-1205-W05M	6009869

M12, 8-pin, PUR, halogen-free

Figure	Connection type head A	Connection type head B	Connecting cable	Type	Part no.
	Female connector, M12, 8-pin, angled, shielded	Cable, open conductor heads	2 m, 8-wire	DOL-1208-W02MAS01	6029224

→ For additional accessories, please see page K-240