



**Rugged metal housing provides exceptional performance in demanding applications**



**Additional information**

Detailed technical data.....G-529  
 Ordering information.....G-530  
 Dimensional drawings.....G-534  
 Adjustments.....G-537  
 Characteristic curves.....G-537  
 Bar diagrams.....G-540  
 Light spot diameter.....G-541  
 Connection diagram.....G-541  
 Recommended accessories....G-542

**Product description**

The W12-3 family features a complete range of photoelectric sensors that are enclosed in a metal housing. There are a large number of variations that are available, including proximity, retro-reflective, through-beam, special laser and clear material versions. These sensors offer

many advantages over conventional optical sensors due to their reliable object detection and monitoring capabilities. Whether in packaging, pharmaceutical, or the food and beverage industries – the W12 family provides a solution for any application.

**At a glance**

- Best-in-class optical performance due to superior OES technology
- Autocollimation with retro-reflective sensors
- Background and foreground suppression with second emitter LED on proximity sensors
- Highly visible, precise light spot and high-energy IR transmitters
- Rugged die-cast zinc housing, optional with Teflon® coating
- Mounting options with through holes, base blind holes, oblong through holes and dovetail
- Flexible sensor settings, monitoring, advanced diagnostics, and visualization thanks to IO-Link

**Your benefits**

- Reliable detection due to superior ASIC (application-specific integrated circuit) technology and immunity to optical interference factors from the industrial environment
- PinPoint LED technology provides a bright, small and precise light spot that enables quick and easy sensor alignment
- Precise switching characteristics ensure reliable object detection, reducing downtime caused by re-adjusting sensors during recipe changes
- Wide range of products enclosed in a rugged metal housing enables application flexibility in a broad range of industrial environments
- Flexible mounting options reduce installation time
- IO-Link provides easy data access from the PLC
- Quick and easy configuration
- Quick and easy integration using function blocks

→ [www.mysick.com/en/W12-3](http://www.mysick.com/en/W12-3)

For more information, just enter the link or scan the QR code and get direct access to technical data, CAD design models, operating instructions, software, application examples and much more.



G

## Detailed technical data

### Features

	WTB12-3	WTF12-3	WL12-3	WSE12-3
<b>Sensor principle</b>	Photoelectric proximity sensor		Photoelectric retro-reflective sensor	Through-beam photoelectric sensor
<b>Detection principle</b>	Background suppression	Foreground suppression	Autocollimation	-
<b>Dimensions (W x H x D)</b>	15.6 mm x 48.5 mm x 42 mm			
<b>Housing design (light emission)</b>	Rectangular			
<b>Sensing range max.</b>	20 mm ... 800 mm <sup>1)</sup> (depending on type)	30 mm ... 500 mm <sup>1)</sup> (depending on type)	0 m ... 7 m <sup>2)</sup> (depending on type)	0 m ... 20 m
<b>Sensing range</b>	20 mm ... 800 mm (depending on type)	30 mm ... 500 mm (depending on type)	0 m ... 5 m <sup>2)</sup> (depending on type)	0 m ... 15 m
<b>Type of light</b>	Visible red light/Infrared light (depending on type)	Visible red light		
<b>Light source</b>	LED <sup>3)</sup> /PinPoint LED <sup>3)</sup> (depending on type)	LED <sup>3)</sup>		
<b>Angle of dispersion</b>	-		Approx. 1.5° / 5° (depending on type)	Approx. 1.5°
<b>Wave length</b>	Visible red light Infrared light		660 nm/640 nm (depending on type) 640 nm	850 nm/880 nm (depending on type) -
<b>Adjustment</b>	Potentiometer, 5 turns/Single teach-in button/Double teach-in button/Cable (depending on type)			
<b>Special feature</b>	Line-shaped light spot (depending on type)	-	Focused optics (depending on type)	-

<sup>1)</sup> Object with 90 % reflectance (referred to standard white, DIN 5033)

<sup>2)</sup> PL80A.

<sup>3)</sup> Average service life of 100,000 h at T<sub>A</sub> = +25 °C.

### Mechanics/electronics

	WTB12-3	WTF12-3	WL12-3	WSE12-3
<b>Supply voltage <sup>1)</sup></b>	10 V DC ... 30 V DC			
<b>Ripple <sup>2)</sup></b>	≤ 5 V <sub>pp</sub>			
<b>Power consumption <sup>3)</sup></b>	≤ 30 mA ... ≤ 60 mA (depending on type)	≤ 30 mA ... ≤ 45 mA (depending on type)	≤ 30 mA ... ≤ 100 mA (depending on type)	-
<b>Power consumption, sender <sup>3)</sup></b>	-			≤ 30 mA
<b>Power consumption, receiver <sup>3)</sup></b>	-			≤ 15 mA ... ≤ 25 mA (depending on type)
<b>Output type</b>	PNP/NPN (depending on type)			
<b>Output function</b>	Complementary			
<b>Switching mode</b>	Light/dark-switching/Dark-switching (depending on type)			
<b>Signal voltage PNP HIGH/LOW</b>	> U <sub>v</sub> - 2,5 V/ca. 0 V			
<b>Signal voltage NPN HIGH/LOW</b>	Approx. VS/< 2.5 V			
<b>Output current I<sub>max.</sub></b>	100 mA			
<b>Response time</b>	Switching frequency 750 Hz <sup>5)</sup>			
	≤ 700 μs <sup>4)</sup>	-		
	Switching frequency 1,500 Hz <sup>5)</sup>			
	≤ 330 μs <sup>4)</sup>			
	-		≤ 100 μs <sup>4)</sup>	-
<b>Connection type</b>	Male connector, M12/Cable/Cable, 3 m <sup>6)</sup> (depending on type)			

	WTB12-3	WTF12-3	WL12-3	WSE12-3
<b>Circuit protection</b>	A <sup>7)</sup> , C <sup>8)</sup> , D <sup>9)</sup>			
<b>Protection class</b>	II			
<b>Weight</b>	Connector	200 g ... 280 g	200 g	200 g ... 250 g
	Cable	120 g		
<b>Polarisation filter</b>	-		✓ (depending on type)	-
<b>IO-Link</b>	✓ (depending on type)			
<b>Enclosure rating</b>	IP 66, IP 67, IP 69K			
<b>Test input sender off</b>	-			TE to 0 V
<b>Ambient operating temperature</b>	-40 °C ... +60 °C			
<b>Ambient storage temperature</b>	-40 °C ... +75 °C			

<sup>1)</sup> Limit values, operation in short-circuit protected network max. 8 A.

<sup>6)</sup> Do not bend below 0 °C.

<sup>2)</sup> May not exceed or fall short of  $V_S$  tolerances.

<sup>7)</sup> A =  $V_S$  connections reverse-polarity protected.

<sup>3)</sup> Without load.

<sup>8)</sup> C = interference suppression.

<sup>4)</sup> Signal transit time with resistive load.

<sup>9)</sup> D = outputs overcurrent and short-circuit protected.

<sup>5)</sup> With light/dark ratio 1:1.

## Ordering information

Other models available at [www.mysick.com/en/W12-3](http://www.mysick.com/en/W12-3)

### WTB12-3

- **Sensor principle:** photoelectric proximity sensor
- **Detection principle:** background suppression
- **Switching mode:** light/dark-switching

Type of light	Sensing range max. <sup>1)</sup>	Light spot size (distance)	Output type	Adjustment	Connection	Connection diagram	Model name	Part no.				
Visible red light	35 mm ... 100 mm	Ø 2 mm (60 mm)	PNP	Potentiometer, 5 turns	Connector M12, 4-pin	Cd-083	WTB12-3P2441	1041421				
					Cable, 4-wire 2 m PVC	Cd-094	WTB12-3P1131	1041413				
					Connector M12, 4-pin	Cd-083	WTB12-3P2431	1041411				
	20 mm ... 350 mm	Ø 6 mm (200 mm)	NPN	Double teach-in button	Connector M12, 4-pin	Cd-083	WTB12-3P2433	1041412				
					Cable, 4-wire 2 m PVC	Cd-094	WTB12-3N1131	1041418				
					Connector M12, 4-pin	Cd-083	WTB12-3N2431	1041416				
					Connector M12, 4-pin	Cd-083	WTB12-3N2433	1041417				
					50 mm ... 800 mm	Ø 9 mm (400 mm)	PNP	Potentiometer, 5 turns	Connector M12, 4-pin	Cd-083	WTB12-3P2461S01	1051967
									Cable, 4-wire 2 m PVC	Cd-094	WTB12-3P1111	1041424
Infrared light	20 mm ... 600 mm	15 mm x 15 mm (200 mm)	PNP	Potentiometer, 5 turns	Cable, 4-wire 3 m PVC	Cd-094	WTB12-3P1711	1041426				
					Connector M12, 4-pin	Cd-083	WTB12-3P2411	1041422				
					Connector M12, 4-pin	Cd-083	WTB12-3P2413	1041423				
			NPN	Double teach-in button	Cable, 4-wire 2 m PVC	Cd-094	WTB12-3N1111	1041429				
					Cable, 4-wire 3 m PVC	Cd-094	WTB12-3N1711	1041430				
					Connector M12, 4-pin	Cd-083	WTB12-3N2411	1041427				
					Connector M12, 4-pin	Cd-083	WTB12-3N2413	1041428				

<sup>1)</sup> Object with 90 % reflectance (referred to standard white, DIN 5033)

G

### WTB12-3, line-shaped light spot

- **Sensor principle:** photoelectric proximity sensor
- **Detection principle:** background suppression
- **Type of light:** visible red light
- **Switching mode:** light/dark-switching

Sensing range max. <sup>1)</sup>	Light spot size (distance)	Output type	Adjustment	Connection	Connection diagram	Model name	Part no.
30 mm ... 500 mm	50 mm x 5 mm (200 mm)	PNP	Potentiometer, 5 turns	Connector M12, 4-pin	Cd-083	WTB12-3P2461S58	1047850

<sup>1)</sup> Object with 90% reflectance (referred to standard white, DIN 5033)



### WTB12-3, IO-Link

- **Sensor principle:** photoelectric proximity sensor
- **Detection principle:** background suppression
- **Type of light:** visible red light
- **Switching mode:** light/dark-switching
- **Output type:** PNP
- **Adjustment:** cable, single teach-in button

Sensing range max. <sup>1)</sup>	Light spot size (distance)	IO-Link	Advanced functions	Connection	Connection diagram	Model name	Part no.
20 mm ... 350 mm	15 mm x 15 mm (200 mm)	Standard functions	-	Connector M12, 4-pin	Cd-098	WTB12C-3P2432	1067771
		Standard functions, advanced functions	Timer, False Tripping Suppression (Debouncing)			WTB12C-3P2432A70	1067772
			High-Speed Counter, False Tripping Suppression (Debouncing)			WTB12C-3P2432A71	1067773
			Time Stamp, False Tripping Suppression (Debouncing)			WTB12C-3P2432A91	1060222

<sup>1)</sup> Object with 90% reflectance (referred to standard white, DIN 5033)



### WTF12-3

- **Sensor principle:** photoelectric proximity sensor
- **Detection principle:** foreground suppression
- **Type of light:** visible red light
- **Switching mode:** light/dark-switching

Sensing range max. <sup>1)</sup>	Light spot size (distance)	Output type	Adjustment	Connection	Connection diagram	Model name	Part no.
30 mm ... 175 mm	Ø 2 mm (60 mm)	PNP	Potentiometer, 5 turns	Cable, 4-wire 2 m PVC	Cd-094	WTF12-3P1131	1041406
			Double teach-in button	Connector M12, 4-pin	Cd-083	WTF12-3P2431	1041404
				Connector M12, 4-pin	Cd-083	WTF12-3P2433	1041405
		NPN	Potentiometer, 5 turns	Cable, 4-wire 2 m PVC	Cd-094	WTF12-3N1131	1041410
			Double teach-in button	Connector M12, 4-pin	Cd-083	WTF12-3N2431	1041408
				Connector M12, 4-pin	Cd-083	WTF12-3N2433	1041409

<sup>1)</sup> Object with 90% reflectance (referred to standard white, DIN 5033)

Sensing range max. <sup>1)</sup>	Light spot size (distance)	Output type	Adjustment	Connection	Connection diagram	Model name	Part no.
30 mm ... 500 mm	Ø 7 mm (300 mm)	PNP	Potentiometer, 5 turns	Cable, 4-wire 2 m PVC	Cd-094	WTF12-3P1141	1041402
			Single teach-in button	Connector M12, 4-pin	Cd-083	WTF12-3P2441	1041400
		NPN	Single teach-in button	Connector M12, 4-pin	Cd-083	WTF12-3P2443	1041401
			Potentiometer, 5 turns	Connector M12, 4-pin	Cd-083	WTF12-3N2441	1041403

<sup>1)</sup> Object with 90 % reflectance (referred to standard white, DIN 5033)

## WL12-3

- **Sensor principle:** photoelectric retro-reflective sensor
- **Detection principle:** autocollimation
- **Switching mode:** light/dark-switching
- **Type of light:** visible red light
- **Light spot size (distance):** Ø 100 mm (3 m)

Sensing range max. <sup>1)</sup>	Polarisation filter	Output type	Adjustment	Connection	Connection diagram	Model name	Part no.
0 m ... 7 m	✓	PNP	Potentiometer, 5 turns	Cable, 4-wire 2 m PVC	Cd-094	WL12-3P1131	1041437
				Cable, 4-wire 3 m PVC	Cd-094	WL12-3P1731	1041438
				Connector M12, 4-pin	Cd-083	WL12-3P2431	1041436
		NPN	Potentiometer, 5 turns	Cable, 4-wire 2 m PVC	Cd-094	WL12-3N1131	1041441
				Cable, 4-wire 3 m PVC	Cd-094	WL12-3N1731	1041442
				Connector M12, 4-pin	Cd-083	WL12-3N2431	1041440
	-	PNP	Potentiometer, 5 turns	Cable, 4-wire 2 m PVC	Cd-094	WL12-3P1141	1041445
				Connector M12, 4-pin	Cd-083	WL12-3P2441	1041444
				Cable, 4-wire 2 m PVC	Cd-094	WL12-3N1141	1041447
		NPN	Potentiometer, 5 turns	Cable, 4-wire 2 m PVC	Cd-094	WL12-3N1141	1041447
				Connector M12, 4-pin	Cd-083	WL12-3N2441	1041446

<sup>1)</sup> PL80A.

## WL12-3, alarm output

- **Sensor principle:** photoelectric retro-reflective sensor
- **Detection principle:** autocollimation
- **Switching mode:** dark-switching
- **Type of light:** visible red light
- **Light spot size (distance):** Ø 100 mm (3 m)

Sensing range max. <sup>1)</sup>	Polarisation filter	Output type	Adjustment	Connection	Connection diagram	Model name	Part no.
0 m ... 7 m	✓	PNP	Potentiometer, 5 turns	Connector M12, 4-pin	Cd-110	WL12-3V2431	1041537

<sup>1)</sup> PL80A.



### WL12-3, focused optics

- **Sensor principle:** photoelectric retro-reflective sensor
- **Detection principle:** autocollimation
- **Switching mode:** light/dark-switching
- **Type of light:** visible red light
- **Light spot size (distance):** Ø 2 mm (90 mm)

Sensing range max. <sup>1)</sup>	Polarisation filter	Output type	Adjustment	Connection	Connection diagram	Model name	Part no.
0 m ... 2 m	✓	PNP	Potentiometer, 5 turns	Cable, 4-wire 2 m PVC	Cd-094	WL12-3P1151	1041449
				Connector M12, 4-pin	Cd-083	WL12-3P2451	1041448
		NPN	Potentiometer, 5 turns	Cable, 4-wire 2 m PVC	Cd-094	WL12-3N1151	1041451
				Connector M12, 4-pin	Cd-083	WL12-3N2451	1041450
	-	PNP	Potentiometer, 5 turns	Cable, 4-wire 2 m PVC	Cd-094	WL12-3P1161	1041453
				Connector M12, 4-pin	Cd-083	WL12-3P2461	1041452
		NPN	Potentiometer, 5 turns	Cable, 4-wire 2 m PVC	Cd-094	WL12-3N1161	1041455
				Connector M12, 4-pin	Cd-083	WL12-3N2461	1041454

<sup>1)</sup> PL80A.



### WL12-3, IO-Link

- **Sensor principle:** photoelectric retro-reflective sensor
- **Detection principle:** autocollimation
- **Type of light:** visible red light
- **Output type:** PNP
- **Switching mode:** light/dark-switching
- **Adjustment:** cable, single teach-in button

Sensing range max. <sup>1)</sup>	Polarisation filter	IO-Link	Advanced functions	Connection	Connection diagram	Model name	Part no.
0 m ... 7 m	✓	Standard functions	-	Connector M12, 4-pin	Cd-098	WL12C-3P2432	1067774
		Standard functions, advanced functions	Timer,			WL12C-3P2432A70	1067775
			False Tripping Suppression (Debouncing)			WL12C-3P2432A71	1067776
			High-Speed Counter, False Tripping Suppression (Debouncing) Time Stamp, False Tripping Suppression (Debouncing)			WL12C-3P2432A91	1067777

<sup>1)</sup> PL80A.

### WSE12-3

- **Sensor principle:** through-beam photoelectric sensor
- **Switching mode:** light/dark-switching
- **Type of light:** visible red light

Sensing range max.	Light spot size (distance)	Output type	Adjustment	Connection	Connection diagram	Model name	Part no.
0 m ... 20 m	Ø 220 mm (15 mm)	PNP	Potentiometer, 5 turns	Cable, 4-wire 2 m PVC	Cd-088	WSE12-3P1131	1041460
				Connector M12, 4-pin	Cd-072	WSE12-3P2431	1041459
		NPN	Potentiometer, 5 turns	Cable, 4-wire 2 m PVC	Cd-088	WSE12-3N1131	1041463
				Connector M12, 4-pin	Cd-072	WSE12-3N2431	1041462





WSE12-3

- **Sensor principle:** through-beam photoelectric sensor
- **Type of light:** visible red light
- **Light spot size:** Ø 220 mm (15 mm)
- **Switching mode:** light/dark-switching
- **Output type:** PNP

Sensing range max.	IO-Link	Advanced functions	Connection	Connection diagram	Model name	Part no.
0 m ... 20 m	Standard functions	-	Connector M12, 4-pin	Cd-268	WSE12C-3P2430	1067780
	Standard functions, advanced functions	Timer, False Tripping Suppression (Debouncing)			WSE12C-3P2430A70	1067781
		High-Speed Counter, False Tripping Suppression (Debouncing)			WSE12C-3P2430A71	1067782
		Time Stamp, False Tripping Suppression (Debouncing)			WSE12C-3P2430A91	1067783

Dimensional drawings

Dimensions in mm (inch)

WTB12-3, potentiometer

G

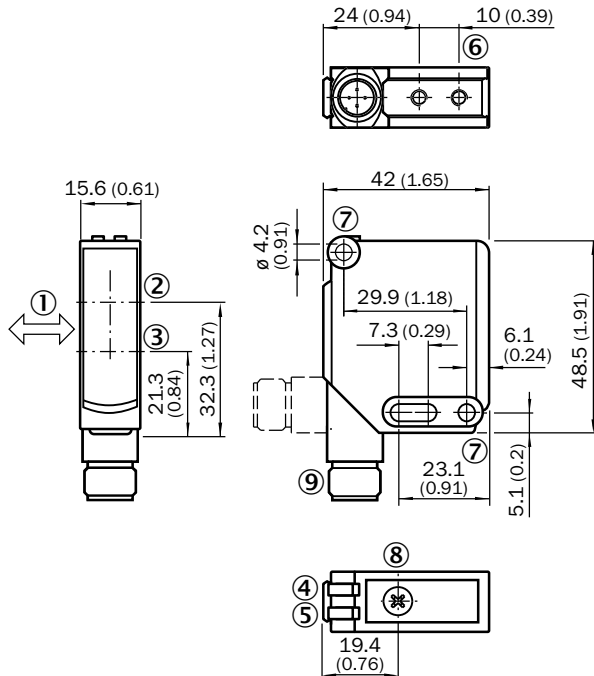

- ① Standard direction of the material being detected
- ② Optical axis, receiver
- ③ Optical axis, sender
- ④ Status indicator LED green: power on
- ⑤ Status indicator LED, yellow: Status of received light beam
- ⑥ M4 threaded mounting hole, 4 mm deep
- ⑦ Mounting hole, Ø 4.2 mm
- ⑧ Sensing range adjustment: potentiometer
- ⑨ Connection

**WTB12-3, double teach-in button**

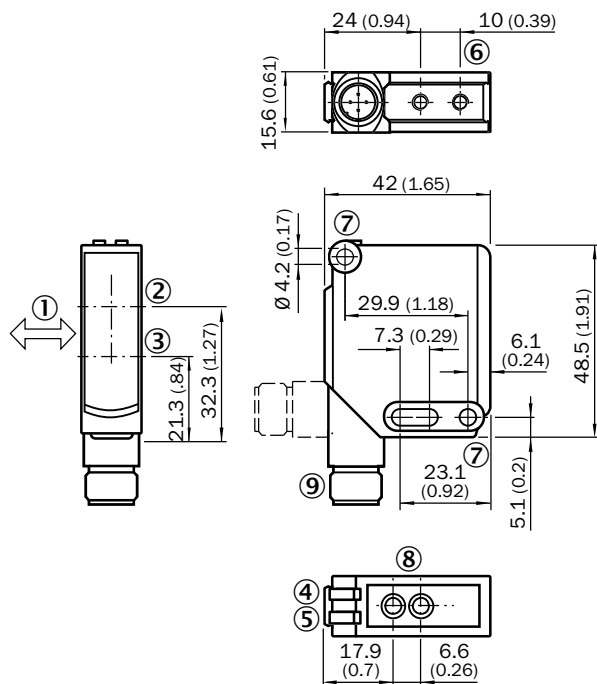

- ① Standard direction of the material being detected
- ② Optical axis, receiver
- ③ Optical axis, sender
- ④ Status indicator LED green: power on
- ⑤ Status indicator LED, yellow: Status of received light beam
- ⑥ M4 threaded mounting hole, 4 mm deep
- ⑦ Mounting hole,  $\varnothing$  4.2 mm
- ⑧ Sensing range adjustment: double teach-in button
- ⑨ Connection

**WTB12-3, IO-Link**

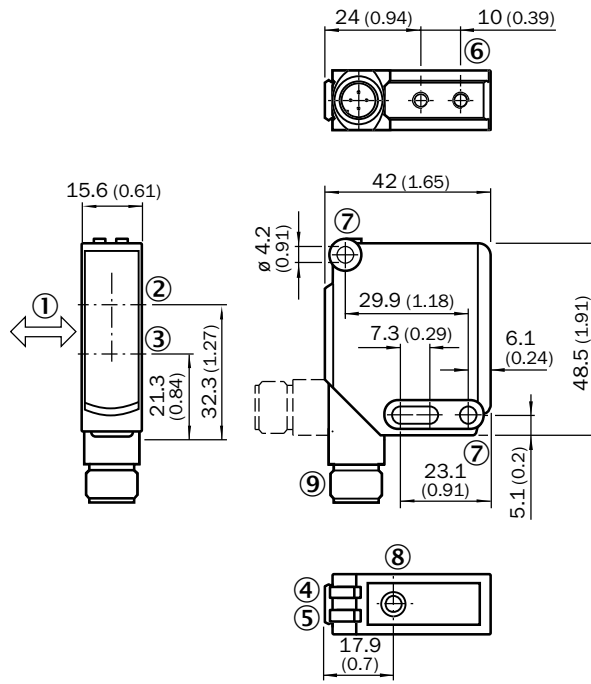

- ① Standard direction of the material being detected
- ② Optical axis, receiver
- ③ Optical axis, sender
- ④ Green LED indicator: supply voltage active
- ⑤ LED indicator yellow: Light received
- ⑥ M4 threaded mounting hole, 4 mm deep
- ⑦ Mounting hole,  $\varnothing$  4.2 mm
- ⑧ Adjustment sensing range: single teach-in button
- ⑨ Connection

**WTF12-3, potentiometer**

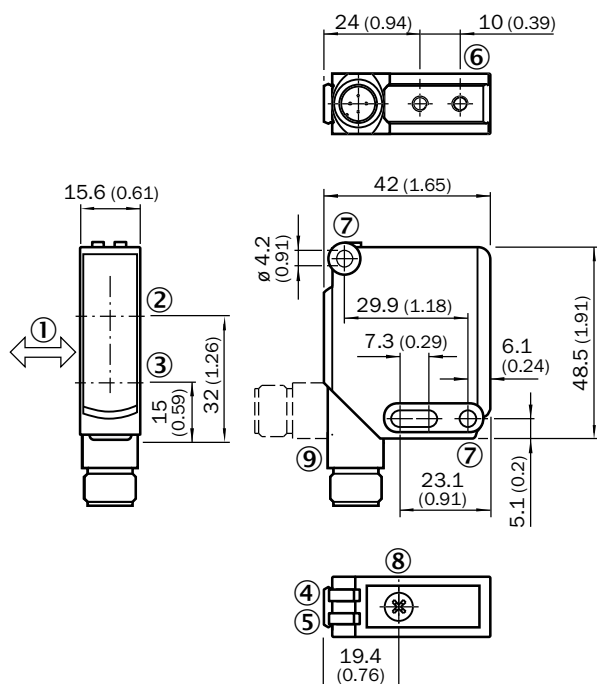

- ① Standard direction of the material being detected
- ② Optical axis, receiver
- ③ Optical axis, sender
- ④ Status indicator LED green: power on
- ⑤ Status indicator LED, yellow: Status of received light beam
- ⑥ M4 threaded mounting hole, 4 mm deep
- ⑦ Mounting hole,  $\varnothing$  4.2 mm
- ⑧ Sensing range adjustment: potentiometer
- ⑨ Connection





**WTF12-3, single teach-in button**

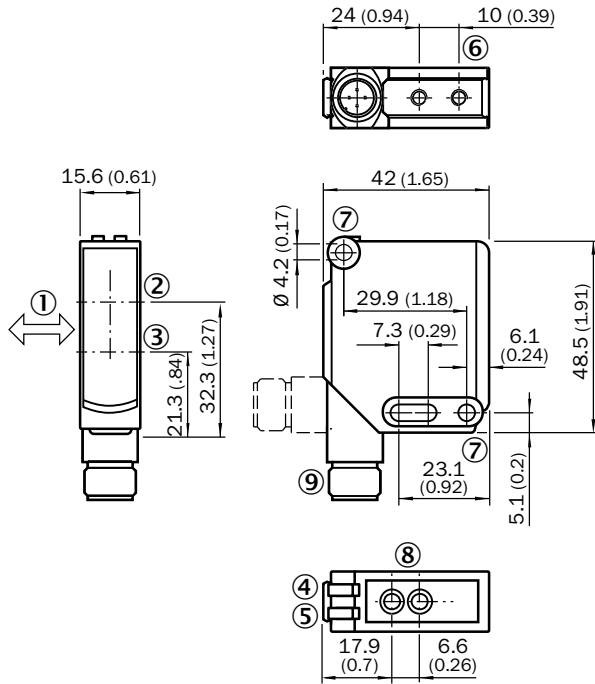

- ① Standard direction of the material being detected
- ② Optical axis, receiver
- ③ Optical axis, sender
- ④ Status indicator LED green: power on
- ⑤ Status indicator LED, yellow: Status of received light beam
- ⑥ M4 threaded mounting hole, 4 mm deep
- ⑦ Mounting hole,  $\varnothing$  4.2 mm
- ⑧ Sensing range adjustment: potentiometer
- ⑨ Connection

**WTF12-3, IO-Link**

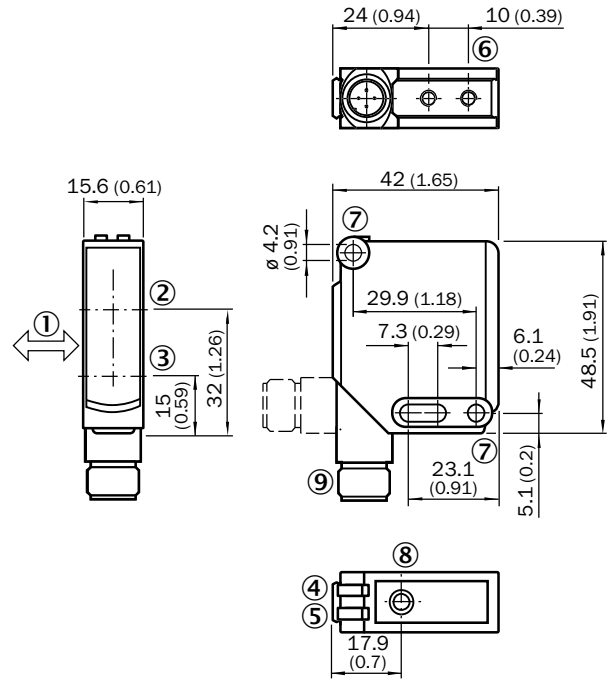

- ① Standard direction of the material being detected
- ② Optical axis, receiver
- ③ Optical axis, sender
- ④ Green LED indicator: supply voltage active
- ⑤ LED indicator yellow: Light received
- ⑥ M4 threaded mounting hole, 4 mm deep
- ⑦ Mounting hole,  $\varnothing$  4.2 mm
- ⑧ Adjustment sensing range: single teach-in button
- ⑨ Connection



**WL12-3, WSE12-3**

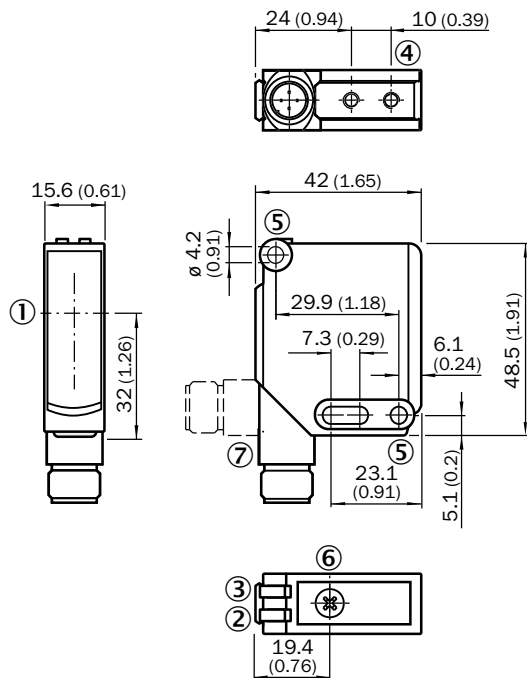

- ① Optical axis
- ② LED indicator yellow: Light received
- ③ Green LED indicator: supply voltage active
- ④ M4 threaded mounting hole, 4 mm deep
- ⑤ Mounting hole,  $\varnothing$  4.2 mm
- ⑥ Sensitivity adjustment: poti
- ⑦ Connection

## Adjustments

**WTB12-3, WTF12-3, potentiometer**

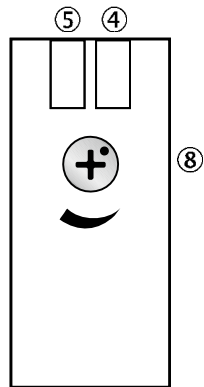

- ④ Green LED indicator: supply voltage active
- ⑤ LED indicator yellow: Light received
- ⑧ Sensing range adjustment: potentiometer

**WTB12-3, WTF12-3, double teach-in button**

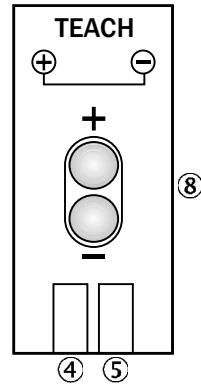

- ④ Green LED indicator: supply voltage active
- ⑤ LED indicator yellow: Light received
- ⑧ Sensing range adjustment: double teach-in button

**WTB12-3, WTF12-3, IO-Link**

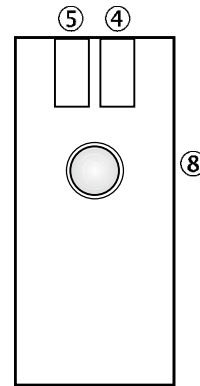

- ④ Status indicator LED green: power on
- ⑤ Status indicator LED, yellow: Status of received light beam
- ⑧ Adjustment sensing range: single teach-in button

**WL12-3, WSE12-3**

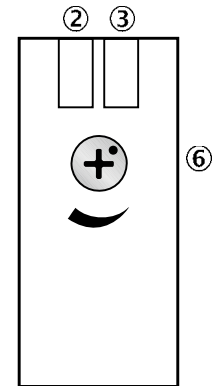

- ② LED indicator yellow: Light received
- ③ Green LED indicator: supply voltage active
- ⑥ Sensitivity adjustment: poti

## Characteristic curves

### Black-white shift

**WTB12-3, red light, 350 mm**

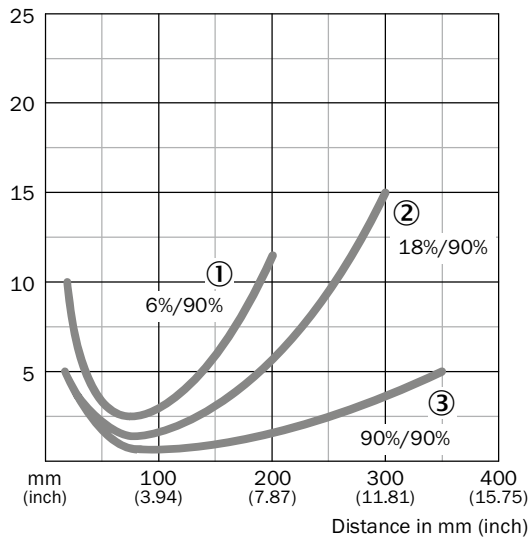

- ① Sensing range on black, 6 % remission
- ② Sensing range on gray, 18 % remission
- ③ Sensing range on white, 90 % remission

**WTB12-3, red light, 800 mm**

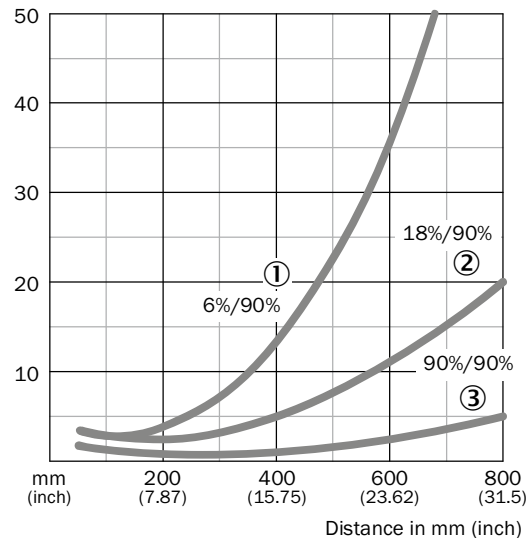

- ① Sensing range on black, 6 % remission
- ② Sensing range on gray, 18 % remission
- ③ Sensing range on white, 90 % remission

G

**WTB12-3, infrared light**

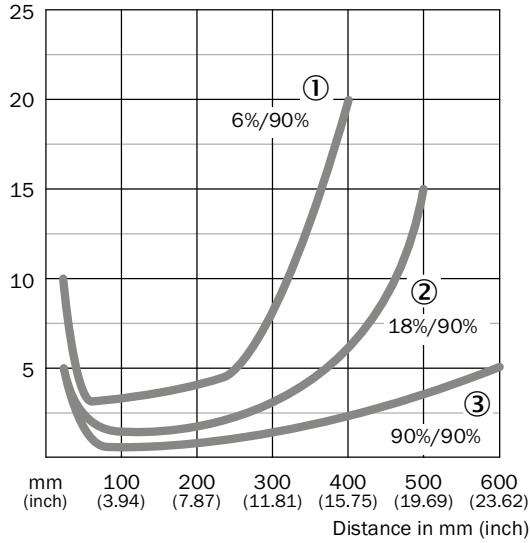

- ① Sensing range on black, 6 % remission
- ② Sensing range on gray, 18 % remission
- ③ Sensing range on white, 90 % remission

**WTF12-3, 175 mm**

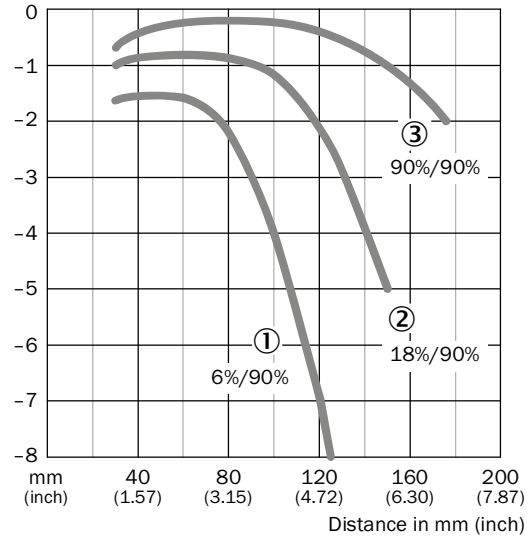

- ① Sensing range on black, 6 % remission
- ② Sensing range on gray, 18 % remission
- ③ Sensing range on white, 90 % remission

**WTF12-3, 500 mm**

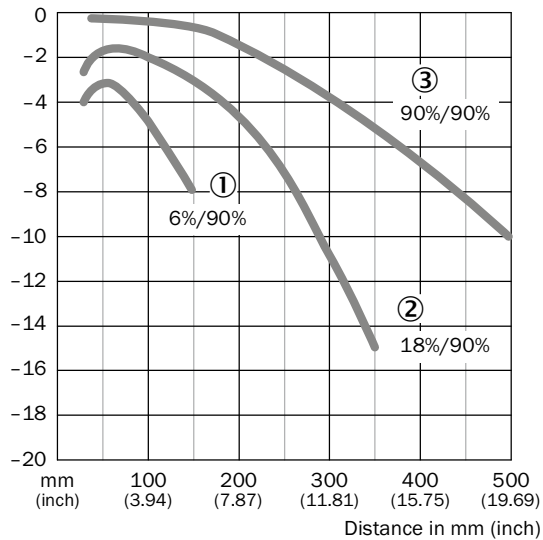

- ① Sensing range on black, 6 % remission
- ② Sensing range on gray, 18 % remission
- ③ Sensing range on white, 90 % remission

G

Operating reserve

**WL12-3**

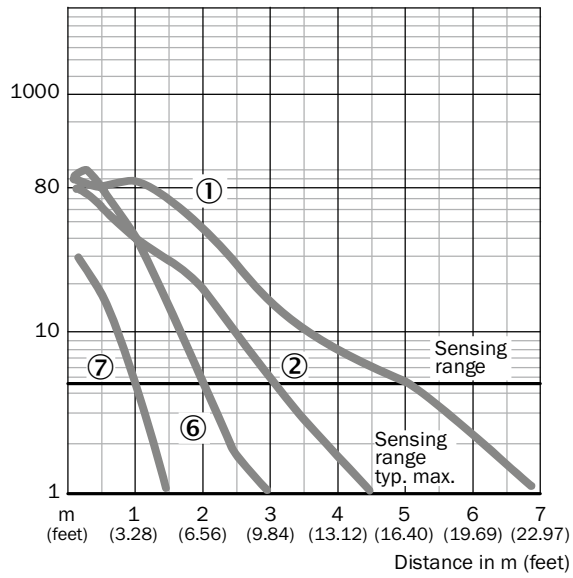

- ① Reflector type PL80A
- ② Reflector type C110A
- ⑥ Reflector type PL20A
- ⑦ Reflective tape

**WL12-3, focused**

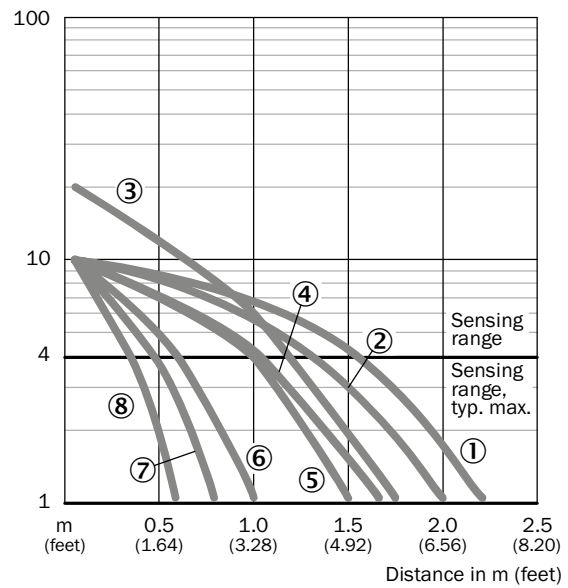

- ① Reflector type C110A
- ② Reflector type PL80A
- ③ Reflector type P205
- ④ Reflector type PL50A
- ⑤ Reflector type PL40A
- ⑥ Reflector type PL30A
- ⑦ Reflector type PL20A
- ⑧ Reflector type DG/IRF6000

**WSE12-3**

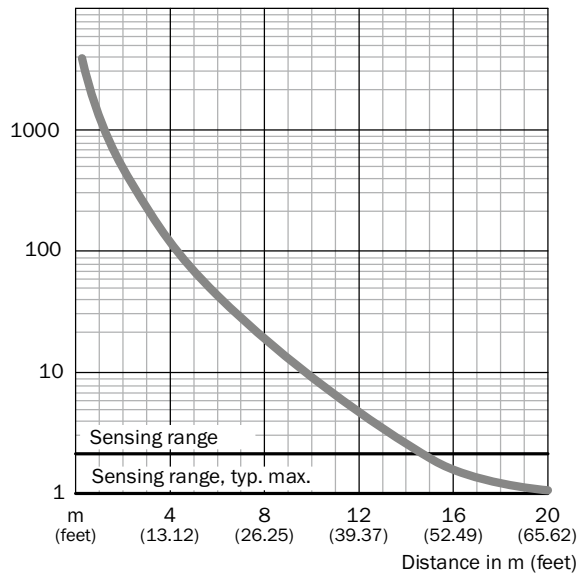

Bar diagrams

WTB12-3, red light, 350 mm

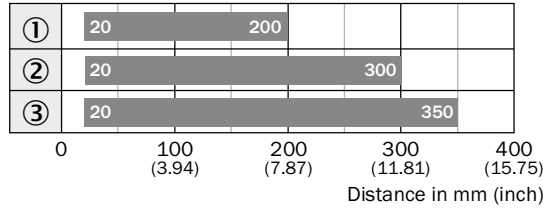

■ Sensing range

- ① Sensing range on black, 6 % remission
- ② Sensing range on gray, 18 % remission
- ③ Sensing range on white, 90 % remission

WTB12-3, infrared light

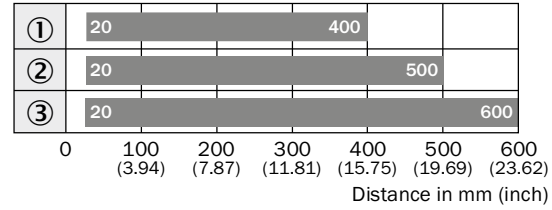

■ Sensing range

- ① Sensing range on black, 6 % remission
- ② Sensing range on gray, 18 % remission
- ③ Sensing range on white, 90 % remission

WTF12-3, 175 mm

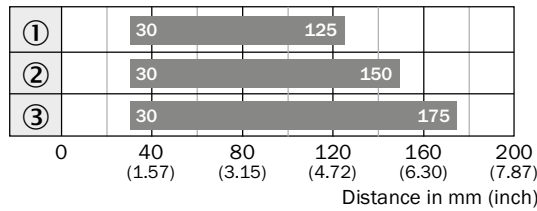

■ Sensing range

- ① Sensing range on black, 6 % remission
- ② Sensing range on gray, 18 % remission
- ③ Sensing range on white, 90 % remission

WTF12-3, 500 mm

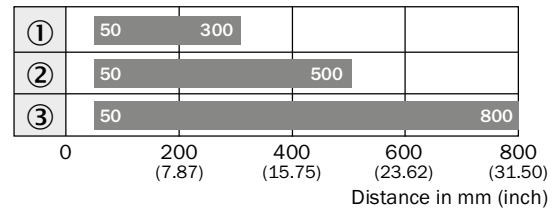

■ Sensing range

- ① Sensing range on black, 6 % remission
- ② Sensing range on gray, 18 % remission
- ③ Sensing range on white, 90 % remission



WL12-3

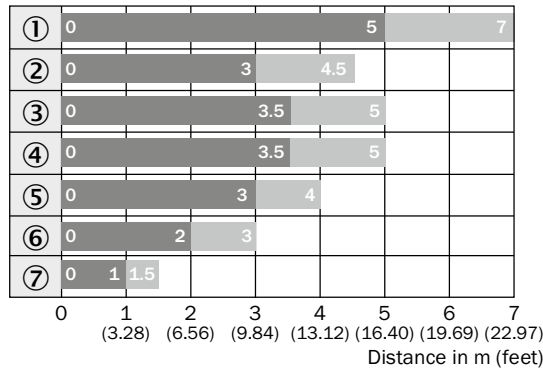

■ Sensing range

■ Sensing range typ. max.

- ① PL80A
- ② C110A
- ③ PL50A
- ④ PL40A
- ⑤ PL30A
- ⑥ PL20A
- ⑦ Reflective tape Diamond Grade

WL12-3, focused

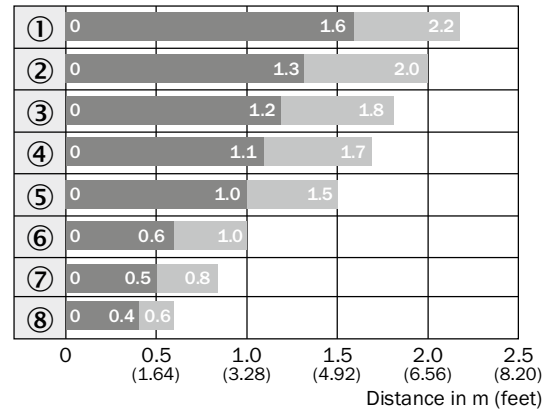

■ Sensing range

■ Sensing range typ. max.

- ① C110A
- ② PL80A
- ③ P250F
- ④ PL50A
- ⑤ PL40A
- ⑥ C30A
- ⑦ PL20A
- ⑧ Reflective tape
- Diamond Grade

WSE12-3

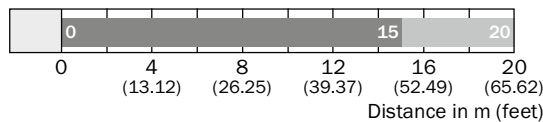

■ Sensing range

■ Sensing range typ. max.

## Light spot diameter

### WTB12-3, line shaped light spot

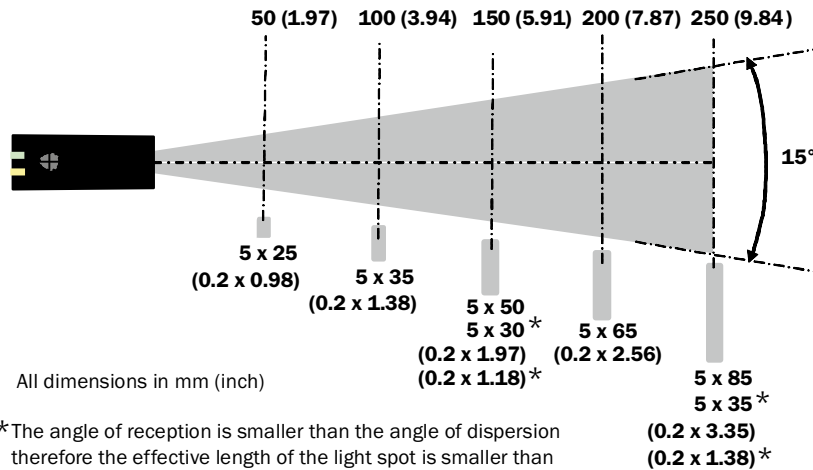

## Connection diagram

### Cd-072

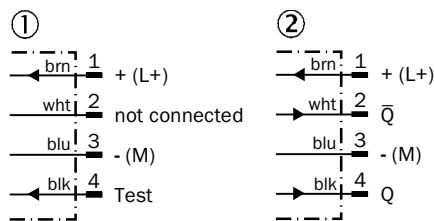

① Sender  
② Receiver

### Cd-083

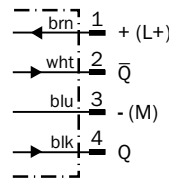

### Cd-088

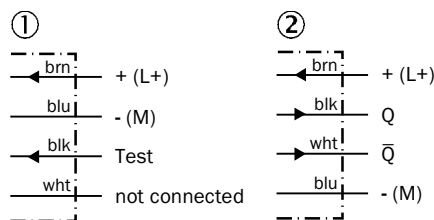

① Sender  
② Receiver

### Cd-094

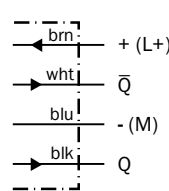

### Cd-098

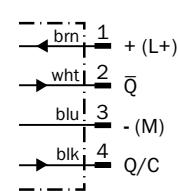

### Cd-110

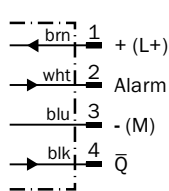

### Cd-268

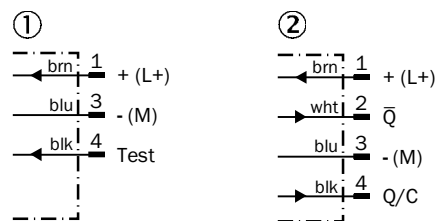

① Sender  
② Receiver

G

## Recommended accessories

### Mounting brackets/plates



#### Mounting brackets

Figure	Material	Description	Model name	Part no.
	Stainless steel	Mounting bracket, large	BEF-WG-W12	2013942
		Mounting bracket, small	BEF-WK-W12	2012938

### Plug connectors and cables

#### Connecting cable (female connector-open)

- Cable material: PVC



Figure	Connection type head A	Connection type head B	Connecting cable	Connector material	Enclosure rating	Model name	Part no.
	Female connector, M12, 4-pin, straight	Cable, open conductor heads	2 m, 4-wire	TPU	IP 67	DOL-1204-G02M	6009382
			5 m, 4-wire	TPU	IP 67	DOL-1204-G05M	6009866
	Female connector, M12, 4-pin, angled, with 3 LEDs	Cable, open conductor heads	2 m, 4-wire	TPU	IP 67	DOL-1204-L02M	6027945
			5 m, 4-wire	TPU	IP 67	DOL-1204-L05M	6027944
PVC	IP 67, IP 69K	DOL-1204-L05MN		6028137			
	Female connector, M12, 4-pin, angled	Cable, open conductor heads	2 m, 4-wire	TPU	IP 67	DOL-1204-W02M	6009383
			5 m, 4-wire	TPU	IP 67	DOL-1204-W05M	6009867
			10 m, 4-wire	TPU	IP 67	DOL-1204-W10M	6010541

## G

### Masks

Figure	Description	Model name	Part no.
	Mask card for WS/WE12-3 with 2 self-adhesive masks each for sender and receiver, slot width X: 0.5 mm/1.0 mm/1.5 mm/2.0 mm	BL-12-SKN	4031815

### Universal bar clamp systems

Figure	Material	Description	Model name	Part no.
	Zinc plated steel (sheet), Diecast zinc (clamp)	Plate N02 for universal clamp bracket	BEF-KHS-N02	2051608
		Plate N03 for universal clamp bracket	BEF-KHS-N03	2051609
		Plate N04 for universal clamp bracket	BEF-KHS-N04	2051610





Device protection (mechanical)

**Protective housing/tubes**

Figure	Material	Description	Model name	Part no.
	Zinc plated steel (protective housing), Diecast zinc (clamp)	Protective housing for universal clamp	BEF-SG-W12-3	2045175

Reflectors

**Angular**

Figure	Material	Description	Model name	Part no.
	PMMA/ABS	Rectangular, screw connection, 47 mm x 47 mm	P250	5304812
		Rectangular, screw connection, 38 mm x 15 mm	PL20A	1012719
		Rectangular, screw connection, 56 mm x 28 mm	PL30A	1002314
		Rectangular, screw connection, 37 mm x 56 mm	PL40A	1012720
		Rectangular, screw connection, 80 mm x 80 mm	PL80A	1003865

**Reflective tape**



Figure	Description	Model name	Part no.
	Self-adhesive, 50 mm x 60 mm	REF-IRF-56	5314244

**Round**

Figure	Material	Description	Model name	Part no.
	PMMA/ABS	Round, screw connection	C110A	5304549

Terminal and alignment brackets

**Terminal brackets**

Figure	Material	Description	Model name	Part no.
	Steel, zinc coated	Double clamp bracket for dovetail mounting	BEF-DKH-W12	2013947
		Clamping block for dovetail mounting	BEF-KH-W12	2013285

→ For additional accessories, please see page L-861